



Product Data Sheet

LGMM-7-27

Low profile MiMo LTE & cellular antenna
with GPS

C/Note	Doc Issue	Date	Approval
01019	1	06.06.2013	J.J.

LTE MIMO Antenna

Low Profile MIMO Antenna with GPS



LGMM-7-27

Rugged low profile design

2x Wideband LTE/cellular elements

Integrated GPS antenna

The Panorama LGMM low profile MIMO antenna range has been designed to support the new generation of vehicular LTE routers.

The antenna enclosure contains three isolated high performance antenna elements; two ultra-wideband elements covering 698-2700MHz support MiMo/diversity at cellular/LTE frequencies and a high performance GPS antenna with an integrated 26dB gain LNA and high quality filtering to combat noise.

The antenna does not require a metallic ground plane, and maintains a high level of performance even when mounted on a non-metallic surface.

Technical Drawing

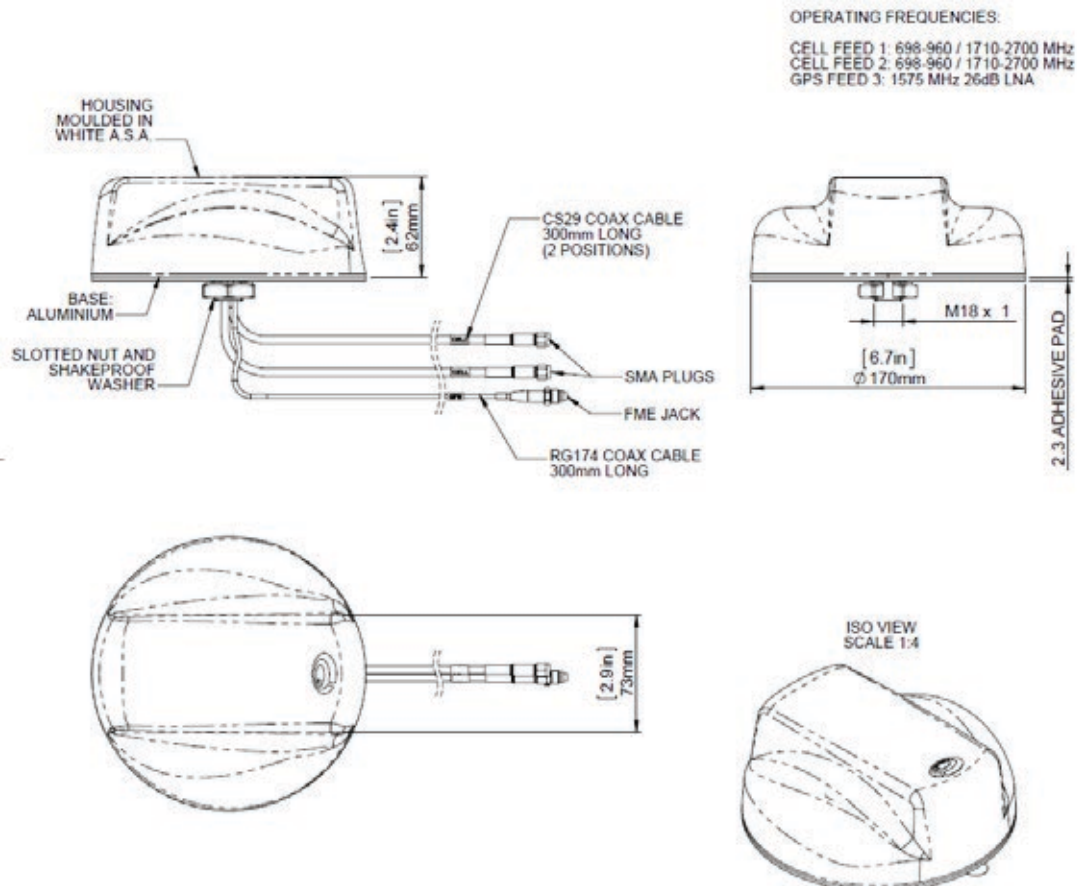

LTE MIMO Antenna

Low Profile MIMO Antenna with GPS

Part No.		LGMM-7-27
Electrical Data		
Frequency Range (MHz)	Elements 1 & 2	698-960 / 1700-2700
Operational Bands	Elements 1 & 2	LTE / Cellular
Peak Gain: Isotropic	Elements 1 & 2 -698-960	2.3dBi
	Elements 1 & 2 -1700-2700	5dBi
VSWR	Elements 1 & 2	< 2.5:1
Isolation (in free space)	Elements 1 & 2	> 15dB
Polarisation		Vertical
Impedance		50Ω
Max Input Power (W)		50
GPS Data		
Frequency Range (MHz)		1575
VSWR		<2.0:1 ± 4MHz
Gain: LNA		26dB
Polarisation		Right Hand Circular
Operating Voltage		3 - 7V DC (fed via coax)
Current		Typical 14mA
Mechanical Data		
Dimensions	Height	2.4" (82mm)
	Diameter	6.7" (176mm)
Operating Temp		-22° / 176°F (-30° / +80°C)
Material		A.S.A & diecast aluminium
Colour		White
Mounting Data		
Mounting type		Panel mount
Max panel thickness		0.236" (6mm)
Mounting hole		3/4" (19mm)
Cable Data		
GPS Cable	Type	RG174
	Diameter	0.11" (2.8mm)
	Length	1' (0.3m)
	Termination	FME (female)
Cell / LTE Cables x2	Type	CS29 (double shielded RG58)
	Diameter	0.2"(5mm)
	Length	1' (0.3m)
	Termination	SMA (male)

LTE MIMO Antenna

Low Profile MIMO Antenna with GPS

Typical VSWR cellular / LTE elements*

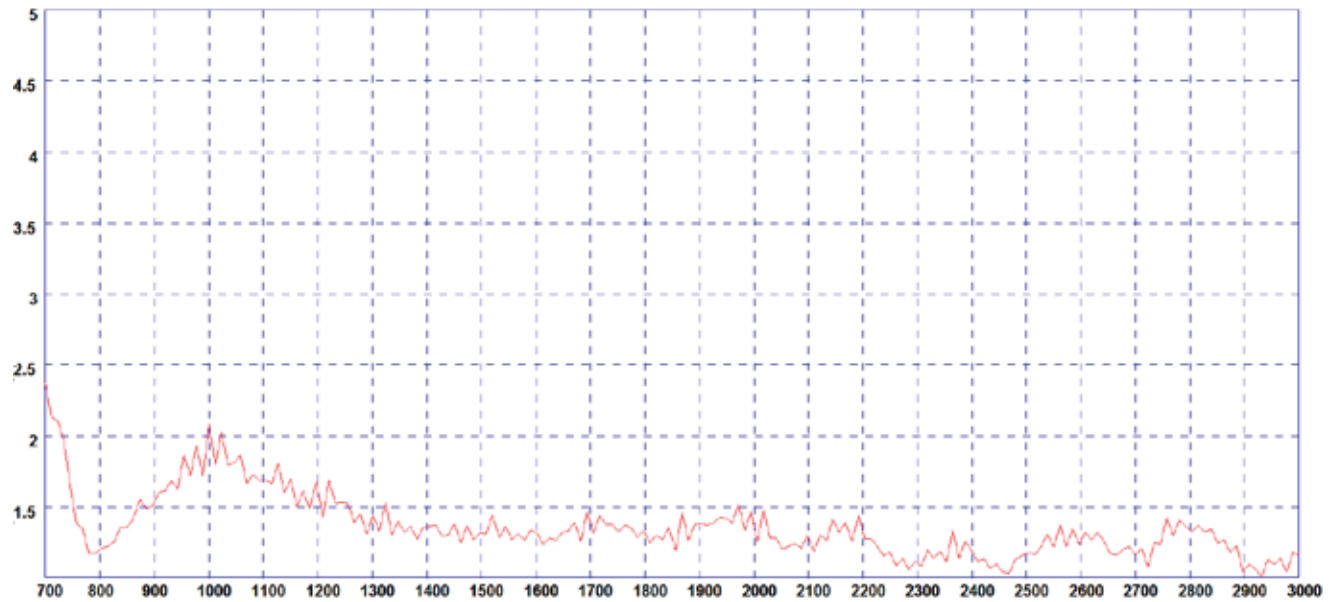

* VSWR measured in free space with 4.5m (15') of CS29 cable.

Typical Isolation cellular / LTE elements*

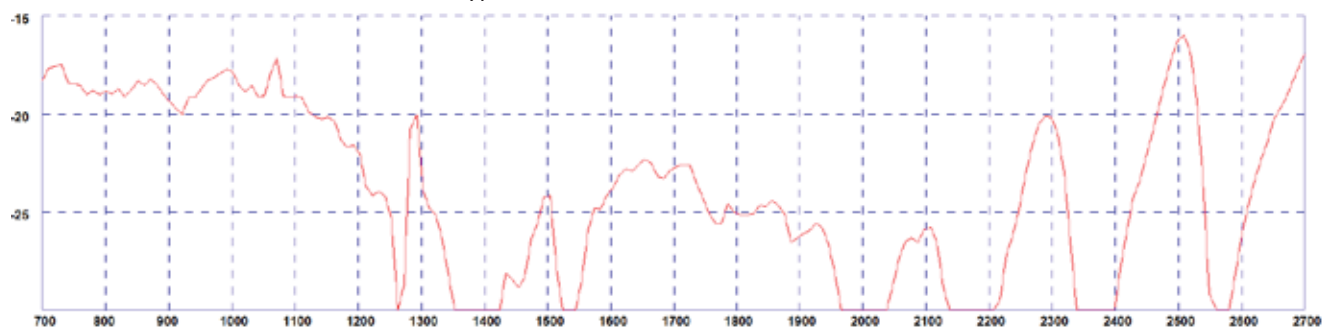

* Isolation measured in free space with 300mm (1') of cable.

LTE MIMO Antenna

Low Profile MIMO Antenna with GPS

Typical 3D Pattern - Elements 1&2 700MHz

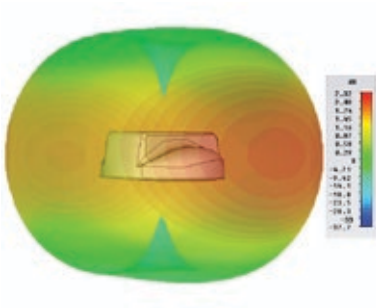

Typical 3D Pattern - Elements 1&2 800MHz

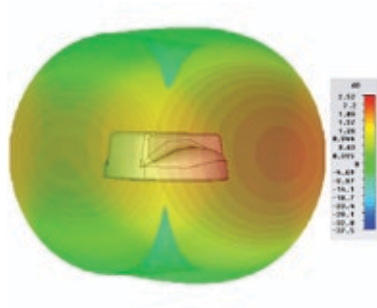

Typical 3D Pattern - Elements 1&2 900MHz

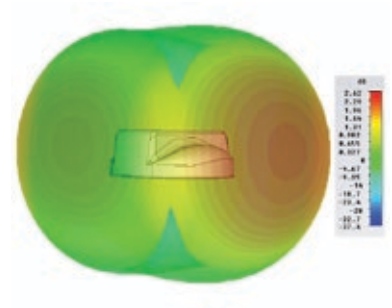

Typical 3D Pattern - Elements 1&2 1800MHz

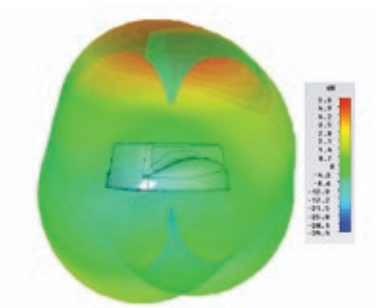

Typical 3D Pattern - Elements 1&2 1900MHz

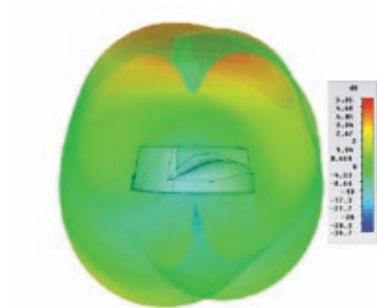

Typical 3D Pattern - Elements 1&2 2100MHz

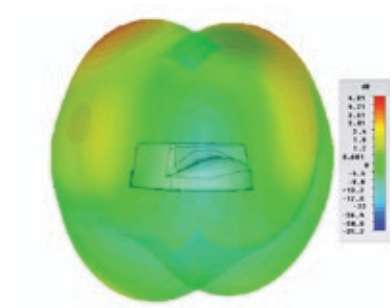

Typical 3D Pattern - Elements 1&2 2400MHz

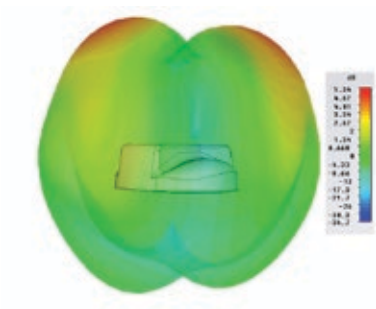

Typical 3D Pattern - Elements 1&2 2500MHz

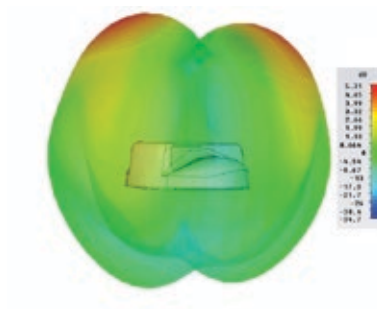

Typical 3D Pattern - Elements 1&2 2600MHz

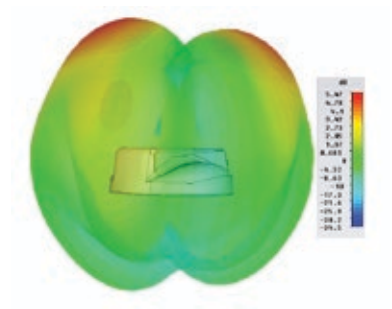

N.B. All pattern and gain measurements taken in free space without additional ground plane.

Panorama Antennas Ltd

Frogmore, London, SW18 1HF, United Kingdom

T: +44 (0)20 8877 4444

F: +44 (0)20 8877 4477

E: sales@panorama-antennas.com

www.panorama-antennas.com

Waiver: The data given above is indicative of the performance of the product/s under particular conditions and does not imply a guarantee of performance. These specifications are subject to change without notice.

Copyright © Panorama Antennas Ltd. All rights reserved.

PANORAMA  ANTENNAS