

Product Data Sheet

TPD-BC3G-26 Range
2G/3G/4G Accessory Paddle
Antennas

C/Note	Doc Issue	Date	Approval
01019	1	05.07.12	J.J.

PANORAMA  ANTENNAS

Mobile Broadband

2G/3G/4G Modem Paddle Antenna



TPD-BC3G-26 Range

8 bands - 700MHz LTE, Quadband cellular, 3G UMTS / AWS, GPS, LTE / WIMAX 2.6GHz

Suitable for bundling with datacards and USB modems
CRC9 or TS9 Connector

The TPD-BC3G-26 range antenna is a range of highly efficient and portable data card antenna. These paddle style antennas are easily positioned on a notebook or laptop screen using a hook and loop pad and the connector is plugged directly into the mobile broadband data card, express card or USB modem.

These antennas have been designed to fit in the packaging that the modems are sold in, making them perfect for bundling as an accessory to improve customer data and retention rates.

Technical Drawing

TPD-BADEP3G-26-05TS9 Shown

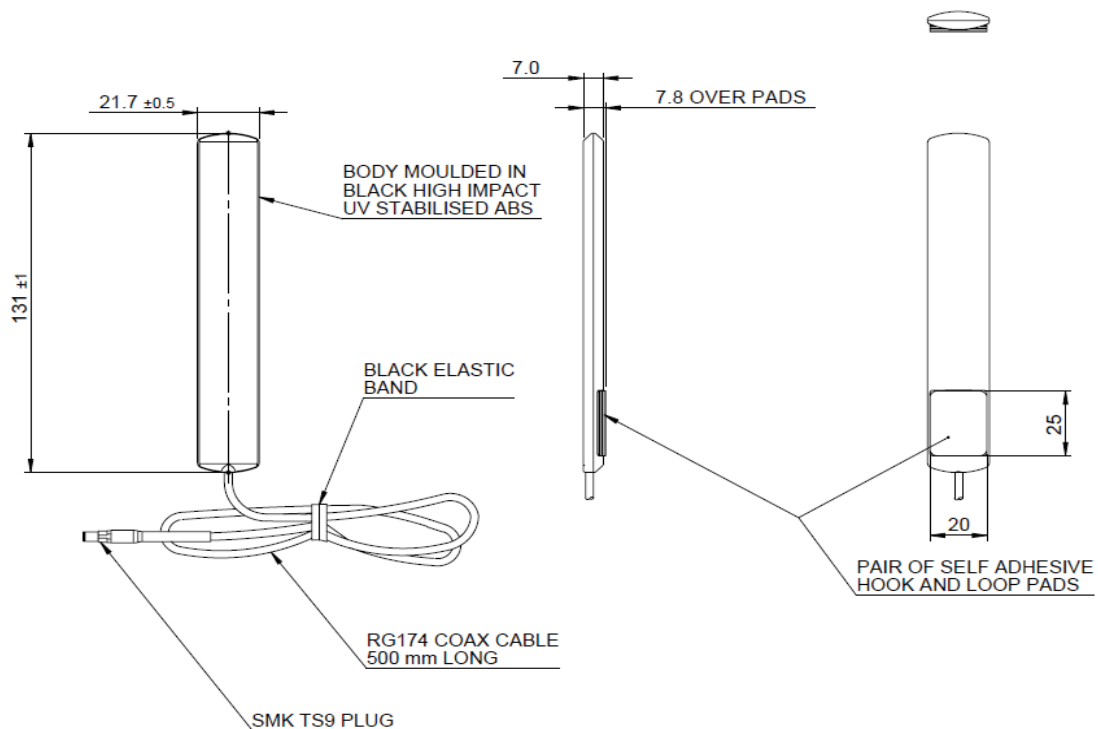

FREQUENCY RANGE.

698 - 960 MHz
1710 - 2170 MHz
2396 - 2700 MHz
1575 MHz

Mobile Broadband 2G/3G/4G Modem Paddle Antenna

3D Plot (700 MHz)

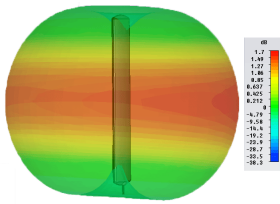

3D Plot (850MHz)

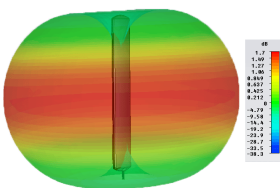

Typical VSWR*

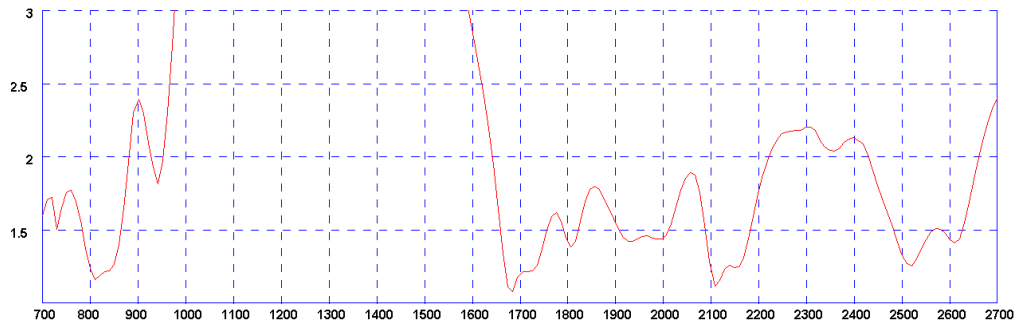

* VSWR measured with 0.5m of RG174 Cable

3D Plot (900MHz)

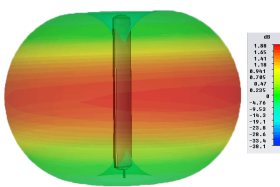

3D Plot (1800MHz)

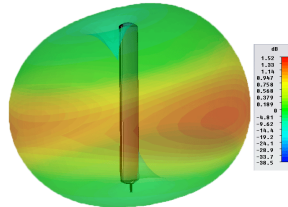

3D Plot (1900/2100 MHz)

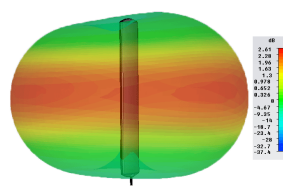

3D Plot (2600MHz)

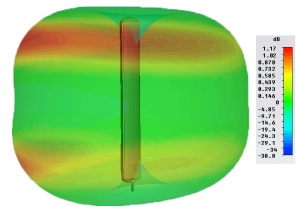

Part No.		TPD-BC3G-26-05TS9	TPD-BC3G-26-05CRC9
Electrical Data			
Frequency Range (MHz)		698-960, 1575, 1710-2170, 2396-2700	698-960, 1575, 1710-2170, 2396-2700
Operational Band		LTE 700, GSM850 / CDMA850, GSM900, GSM1800, PCS1900, 3G UMTS, AWS, LTE/WIMAX2600 & GPS	LTE 700, GSM850 / CDMA850, GSM900, GSM1800, PCS1900, 3G UMTS, AWS, LTE/WIMAX2600 & GPS
VSWR		<2.5:1	<2.5:1
Peak Gain: Isotropic		2dBi	2dBi
Compared to ¼ wave		0dB	0dB
Polarisation		Vertical	Vertical
Pattern		Omnidirectional	Omnidirectional
Impedance		50Ω	50Ω
Max Input Power (W)		10	10
Mechanical Data			
Dimensions (mm)	Length	131 (5.16")	131 (5.16")
	Width	20 (0.79")	20 (0.79")
	Thickness	7(0.27")	7(0.27")
Material		ABS	ABS
Operating Temp (°C)		-40° / 176°F (-40° / +80°C)	-40° / 176°F (-40° / +80°C)
Colour		Black	Black
Mounting Data			
Type		Adhesive hook & loop pad	Adhesive hook and loop pad
Cable Data			
Type		RG174	RG174
Diameter (mm)		2.6 (0.10")	2.6 (0.10")
Length (m)		0.5 (19.7")	0.5 (19.7")
Termination		TS9 plug	CRC9 Plug

Panorama Antennas Ltd

Frogmore, London, SW18 1HF, United Kingdom

T: +44 (0)20 8877 4444

F: +44 (0)20 8877 4477

E: sales@panorama-antennas.com

www.panorama-antennas.com

Waiver: The data given above is indicative of the performance of the product/s under particular conditions and does not imply a guarantee of performance. These specifications are subject to change without notice.

Copyright © Panorama Antennas Ltd. All rights reserved.

PANORAMA  ANTENNAS